



KONDENZÁTORY UCPÁVKOVÉ PÁRY

Kontaktujte nás:

+420 733 156 347 

info@mps-gradior.cz 

 www.mps-gradior.cz

Zadání technických parametrů pro návrh KUP

Ustupní hodnoty

Prutok pary z Lenz.	0.0000 [kg/s]	Entalpie pary z Lenz	3257.00 [kJ/kg]
Prutok pary z pred. ucp.	.1046 [kg/s]	Entalpie pary z pred. ucp.	3399.07 [kJ/kg]
Prutok pary ze zad. ucp.	.1722 [kg/s]	Entalpie pary ze zad. ucp.	3064.37 [kJ/kg]
Prutok vzduchu	.1010 [kg/s]	Merna vlhkost za KUP	.400 [-]
Plocha KUP	45.0000 [m ²]	Teplota vody pred KUP	31.000 [°C]
Prutok vody do KUP	30.5556 [kg/s]		

Vypoctene hodnoty

Vypoctove mnozstvi pary	.4982 [kg/s]	Vypoctove mnozstvi vzdu.	.1818 [kg/s]	Teplota vody za	40.839 [°C]
Entalpie smesi pred KUP	2348.77 [kJ/kg]	Teplota smesi pred KUP	319.90 [°C]	Merny objem smesi pred KUP	2.4648 [m ³ /kg]
Entalpie smesi za KUP	806.35 [kJ/kg]	Teplota smesi za KUP	74.08 [°C]	Merny objem smesi za KUP	1.1709 [m ³ /kg]
Teplota sytosti pred KUP	93.99 [°C]	Teplota sytosti za KUP	74.85 [°C]	Mnozstvi smesi pred KUP	.6800 [kg/s]
Mnozstvi smesi za KUP	.2545 [kg/s]	Objemovy prutok za KUP	.2980 [m ³ /s]	Prutok kondenzatu z KUP	.4255 [kg/s]
Teplny vykon	1258.69 [kW]	Stredni log. teplny spad	48.351 [°C]	Souciniteľ prostupu tepla	578.50 [W/m ² *K]

Technický návrh KUP

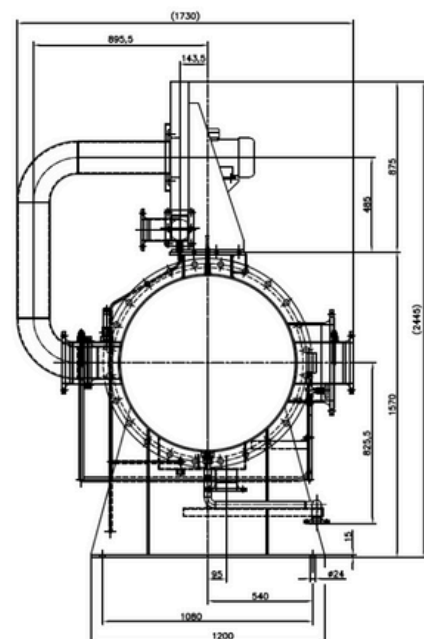
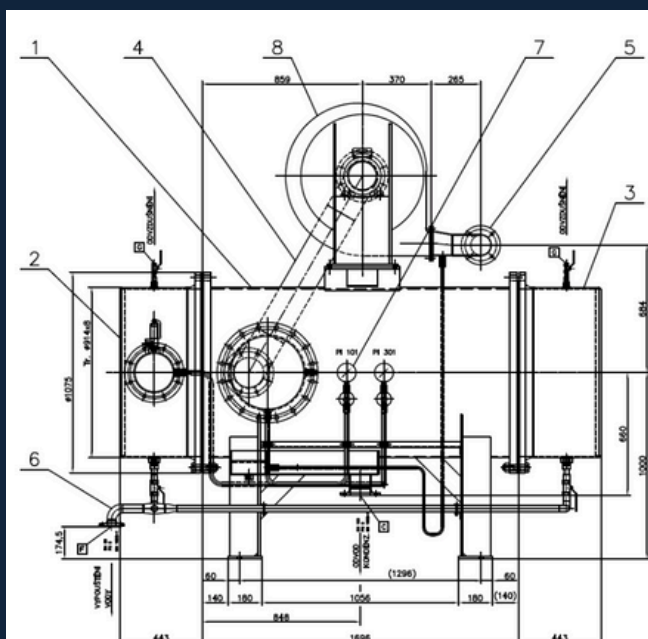

Realizované KUP



Realizované KUP



Realizované KUP

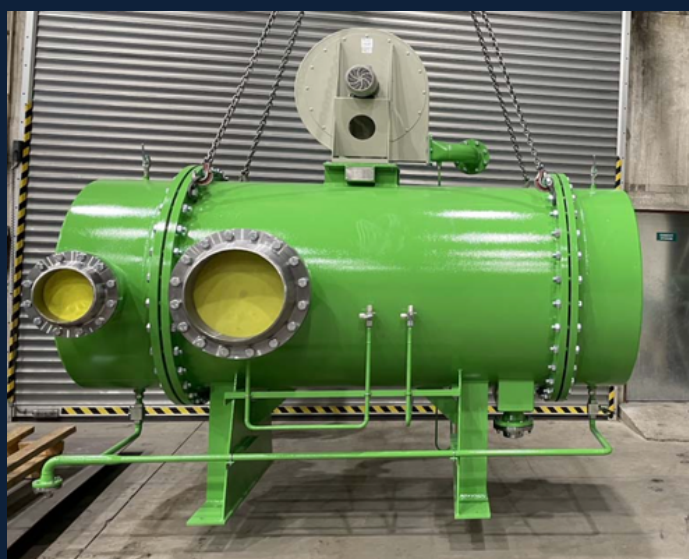
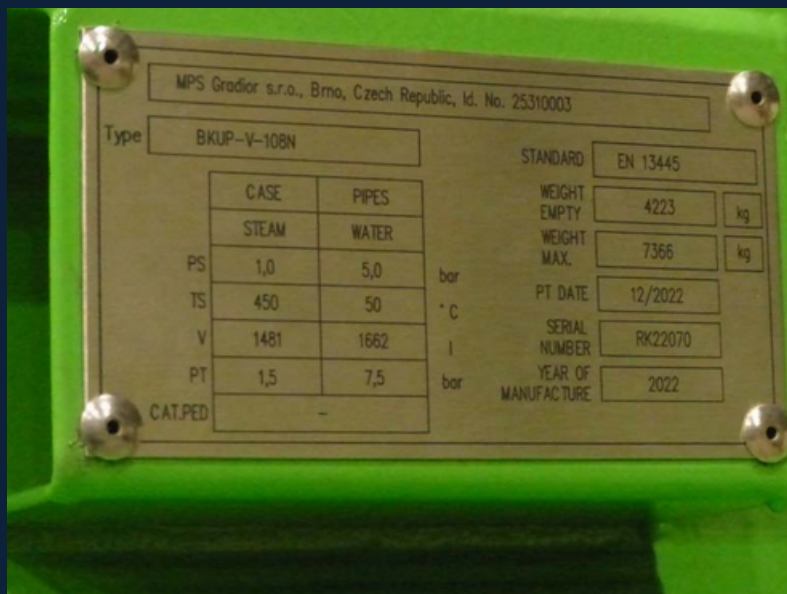

Opravy a repase KUP



Opravy a repase KUP



Opravy a repase KUP



Opravy a repase KUP

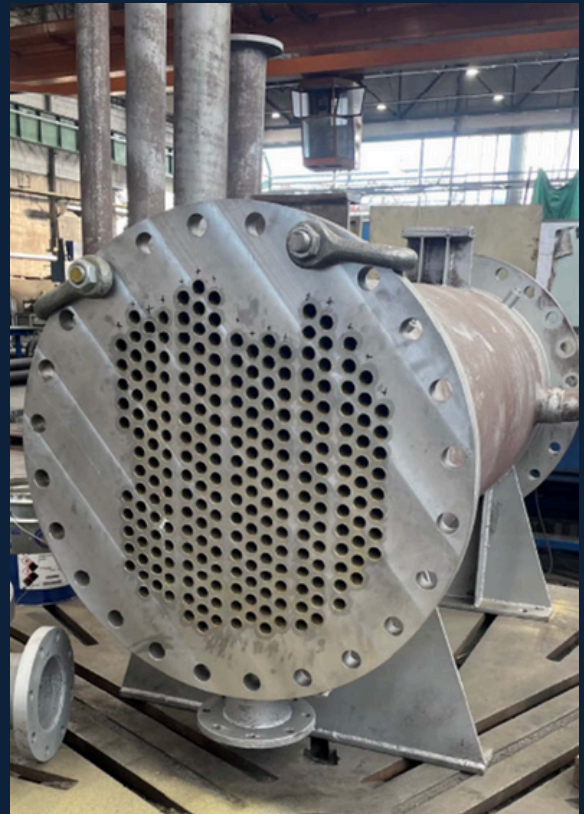
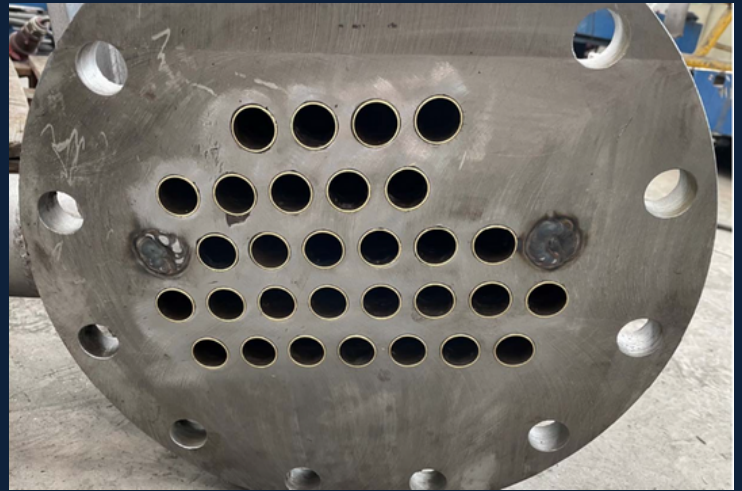
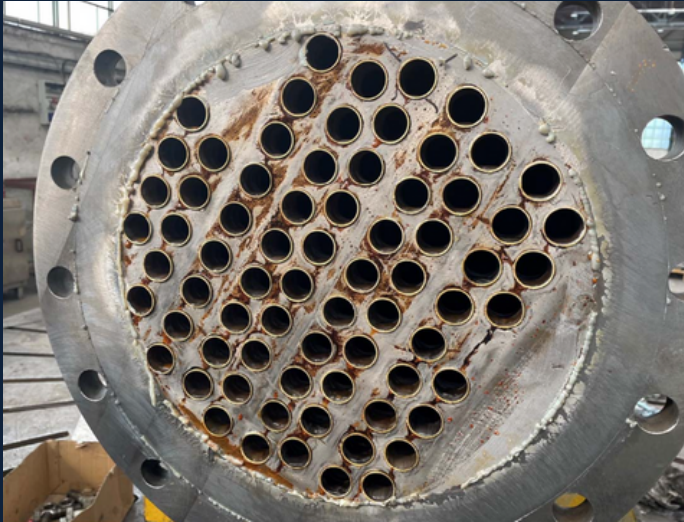
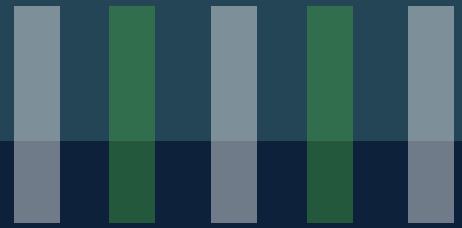

Opravy a repase KUP



Opravy a repase KUP



Adresa:

Zaoralova 3117/13
Brno - Líšeň
628 00
IČ 25310003
DIČ CZ25310003



Miroslav Ftorek / Jednatel

Mobil: +420 602 551 219

E-mail: m.ftorek@mps-gradior.cz

Miroslav Janeček / Obchodně - technický ředitel

Mobil: +420 733 156 347

E-mail: m.janecek@mps-gradior.cz

Kontaktní e-mail: info@mps-gradior.cz

E-mail pro poptávky: poptavky@mps-gradior.cz



www.mps-gradior.cz